



REHAU[®]

Unlimited Polymer Solutions

GENEO[®]

TECHNISCHE INFORMATION

PROFILDRUCK

GENEO® PROFILDRUCK

Blendrahmen

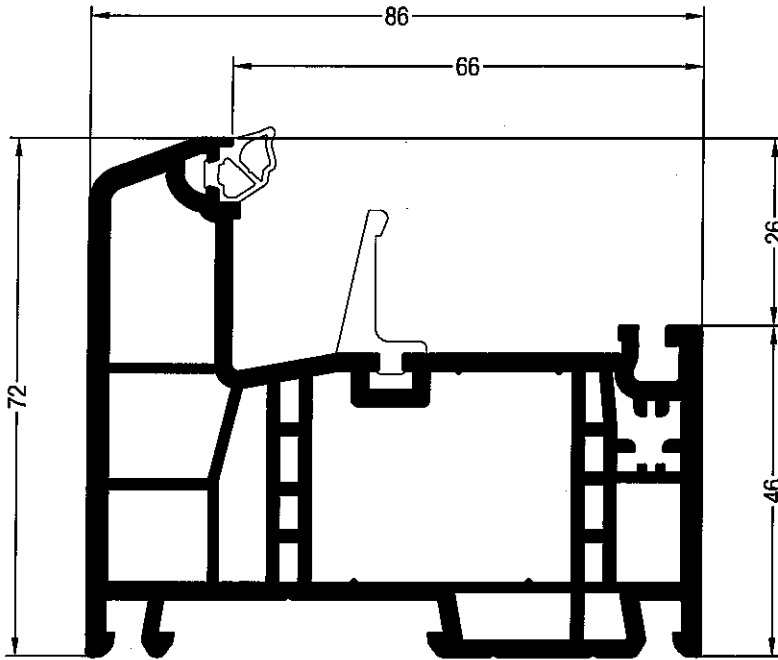

Blendrahmen 72 GENEO®
RAU-FIPRO®

- 1532015
- 1562015
- 24

Blendrahmen 72 REC GENEO®
RAU-FIPRO®

- 1532825
- 24

lx	2,2
ly	0,9

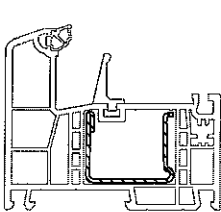

35 x 28

	1244516	1244526
	1,5	2
lx	2,7	3,5
ly	1,3	1,7
	6	6

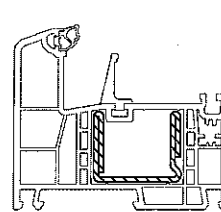

35 x 28

	1244536
	2
lx	5
ly	2
	6

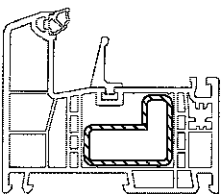

35 x 28

	1238620
	2
lx	3,1
ly	1,8
	6

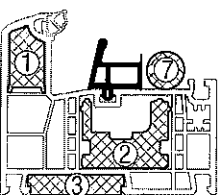

GENEO® PHZ		
	Passivhaus-Mittelsteg	1627079
①	Thermomodul Blir/Pf	1353337
②	Thermomodul 35 x 28	1260013
③	Thermomodul Rastnocken	1353340
⑦	Thermomodul Festverglasung	1353361

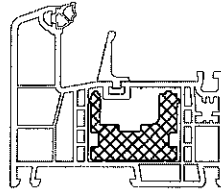

Thermomodul
35 x 28

- 1260013
- 50

GENEO® PROFILDRUCK

Blendrahmen

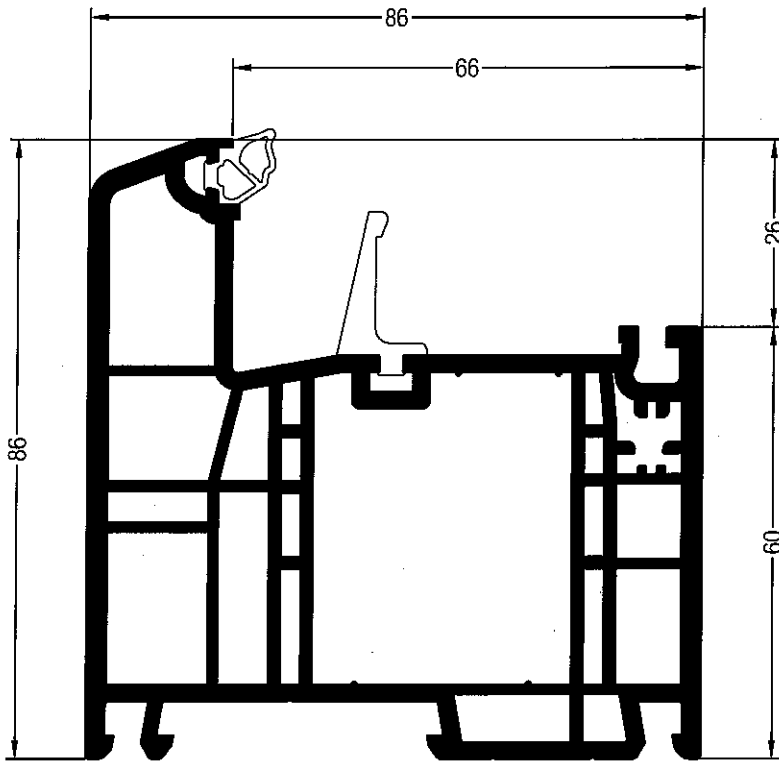

Blendrahmen 86 GENEО®

RAU-FIPRO®

- 1532305**
- 1562305**
- 24

Blendrahmen 86 GENEО® PHZ (mit Passivhaus-Mittelsteg)

RAU-FIPRO®

- 1532325**
- 1562325**
- 24

Blendrahmen 86 REC GENEО®

RAU-FIPRO®

- 1532835**
- 24

Lieferbar ab März 2012.

lx	2,7
ly	1,5

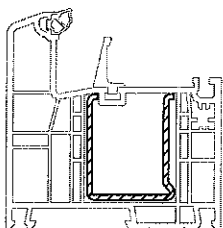

35 x 42

	1350193
	2
lx	4,6
ly	4,5
	6

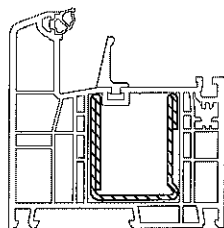

35 x 42

	1238570
	2
lx	6,5
ly	6,1
	6

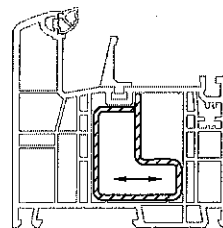

35 x 42

	1353384
	2
lx	3,5
ly	4,6
	6

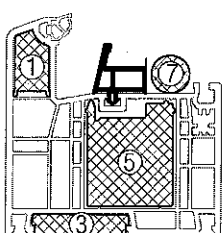

GENEO® PHZ		
	Passivhaus-Mittelsteg	1627079
①	Thermomodul Blr/Pf	1353337
③	Thermomodul Rastrocken	1353340
⑦	Thermomodul Festverglasung	1353361
⑤	Thermomodul 35 x 42	1260023

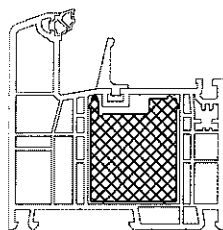

Thermomodul

35 x 42

1260023



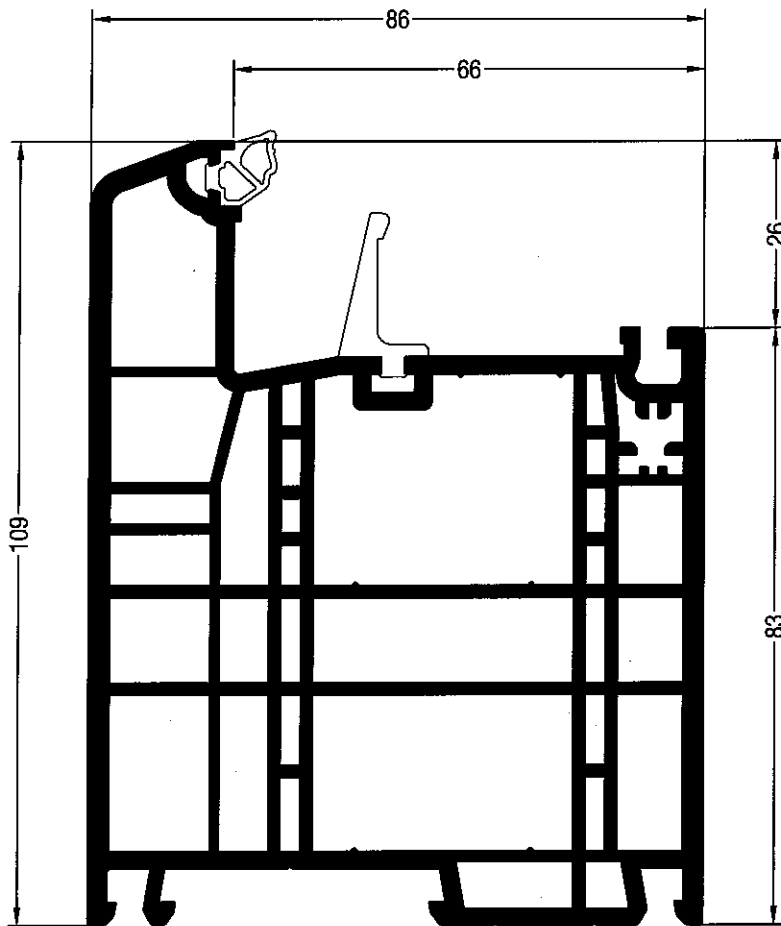

50

GENEO® PROFILDRUCK

Blendrahmen





Blendrahmen 109 GENEО®
RAU-FIPRO®

- 1532125  
 @
 1562125  @
 12

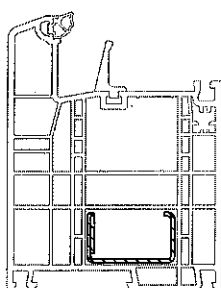
lx	3,3
ly	3,1



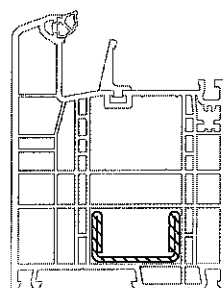

35 x 20

	1261831
	1,5
lx	2,5
ly	0,56
	6



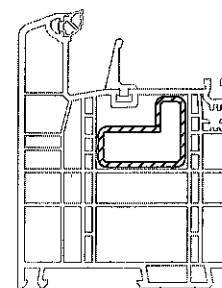

35 x 20

	1351893
	2
lx	3,8
ly	0,77
	6





35 x 28

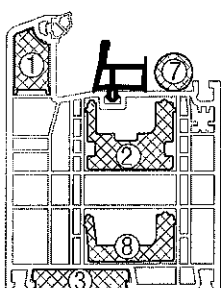

	1238620
	2
lx	3,1
ly	1,8
	6

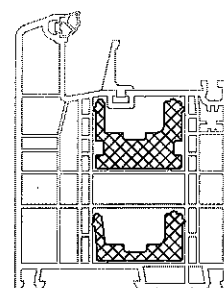

GENEO® PHZ		
	Passivhaus-Mittelsteg	1627079
①	Thermomodul Blr/Pf	1353337
②	Thermomodul 35 x 28	1260013
③	Thermomodul Rastnocken	1353340
⑦	Thermomodul Festverglasung	1353361
⑧	Thermomodul 35 x 20	1260033



Thermomodul 35 x 28
1260013 
 50

Thermomodul 35 x 20
1260033 
 50

Blendrahmen

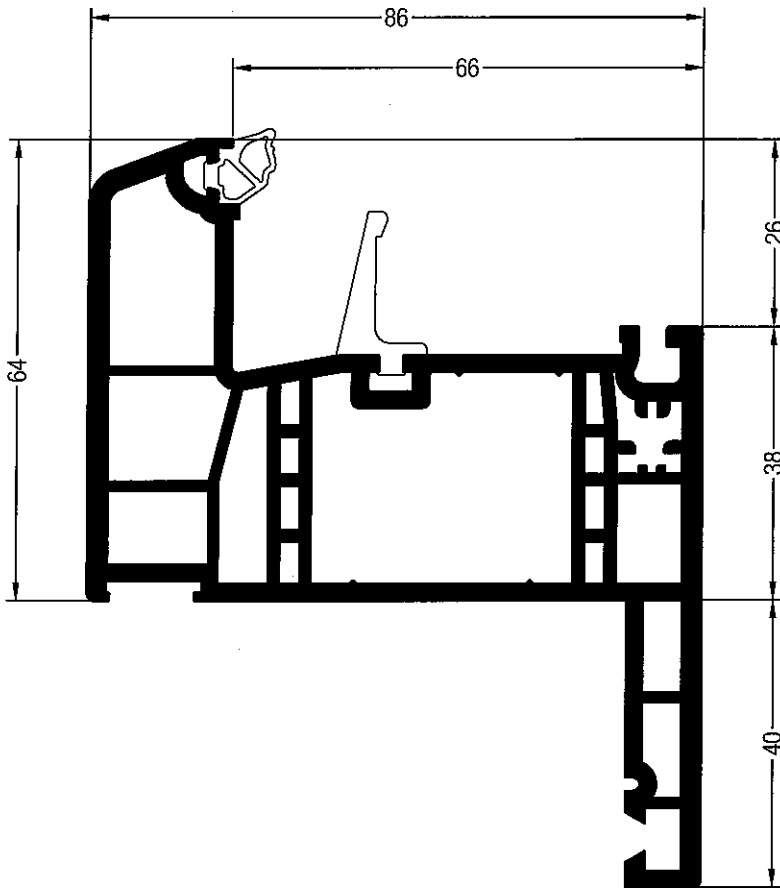

Blendrahmen 64-40 GENEО®
RAU-FIPRO®

- 1532215
- 1562215
- 24

lx	2,6
ly	1,4

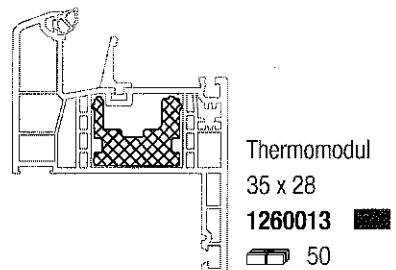
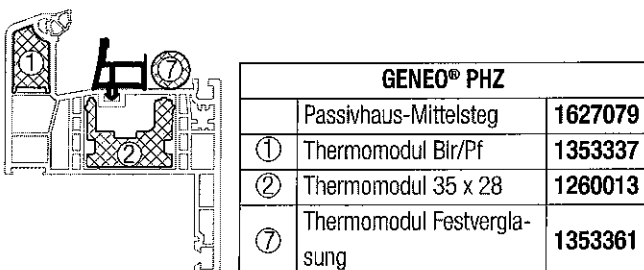
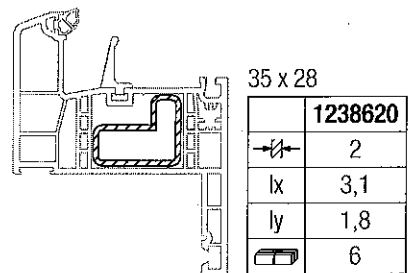
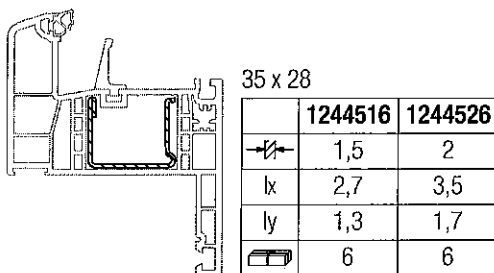
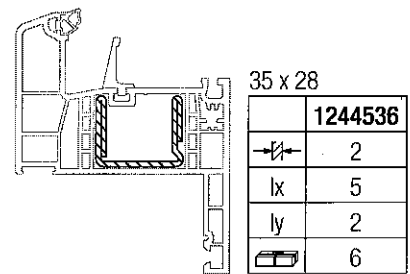

GENEO® PROFILDRUCK

Pfosten-Kämpfer

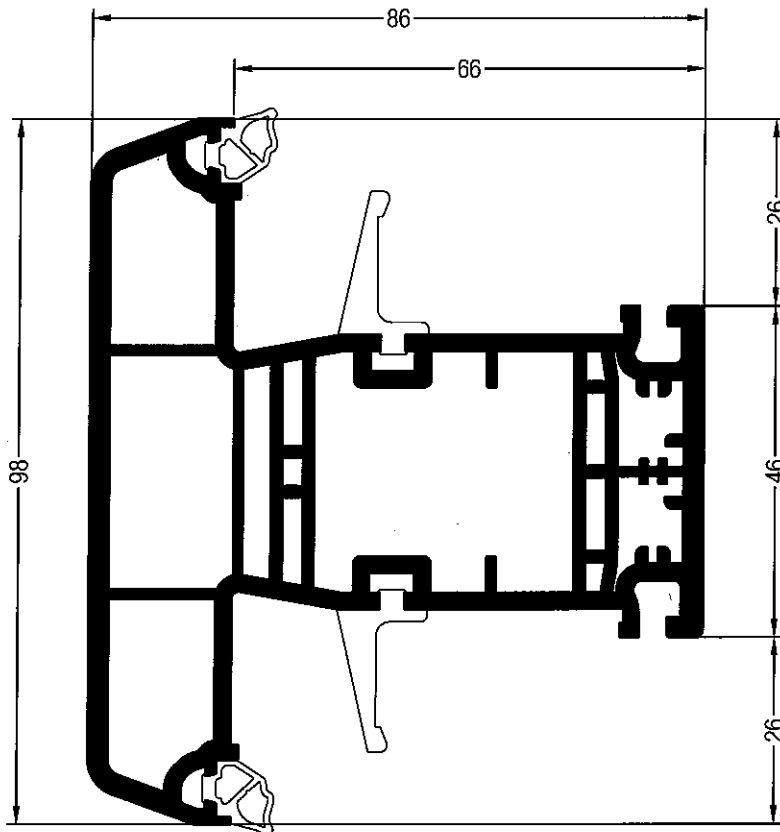

Pfosten 98 GENEО®

RAU-FIPRO®

1532055

1562055

24

Pfosten 98 GENEО® PHZ (mit Passivhaus-Mittelsteg)

RAU-FIPRO®

1532285

1562285

24

lx	2,5
ly	1,4

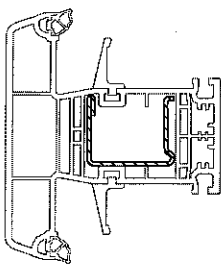

35 x 28

	1244516	1244526
	1,5	2
lx	2,7	3,5
ly	1,3	1,7
	6	6

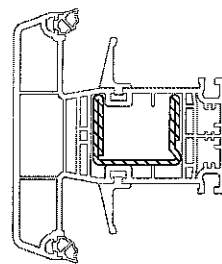

35 x 28

	1244536
	2
lx	5
ly	2
	6

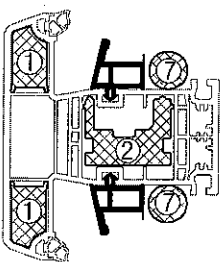

GENEO® PHZ		
	Passivhaus-Mittelsteg	1627079
①	Thermomodul Blr/Pf	1353337
②	Thermomodul 35 x 28	1260013
⑦	Thermomodul Festverglasung	1353361

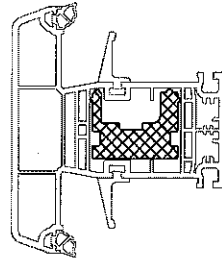

Thermomodul

35 x 28

1260013

50

GENEO® PROFILDRUCK

Pfosten-Kämpfer

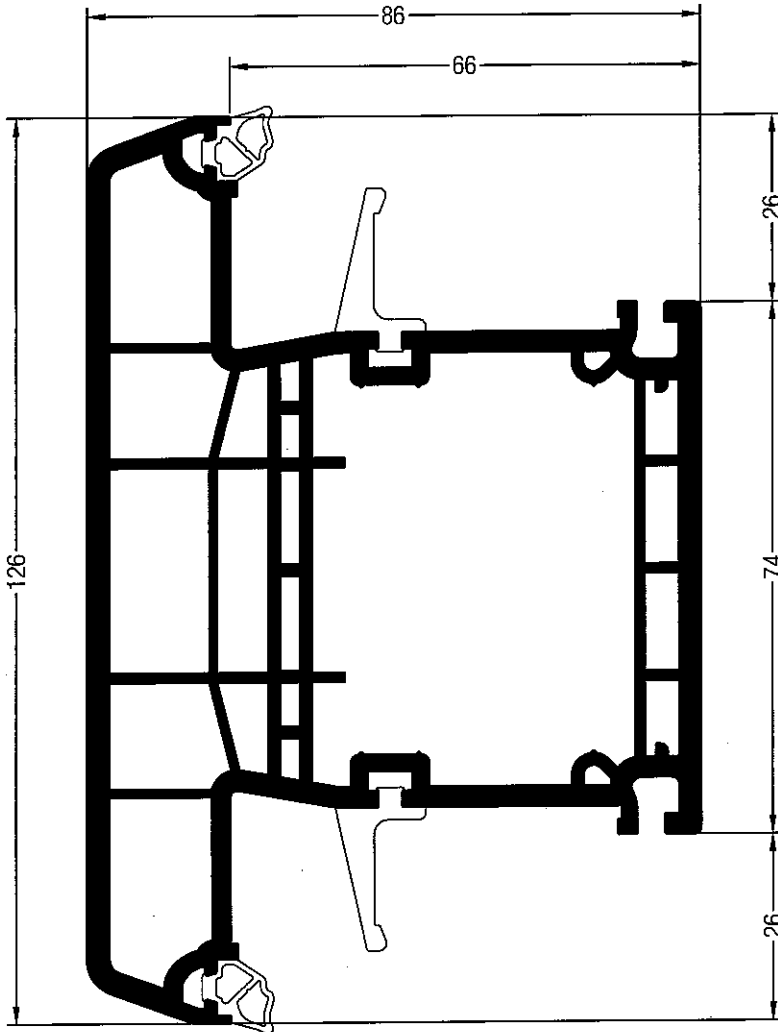

Pfosten 126 GENEО®



1532345 

1562345 

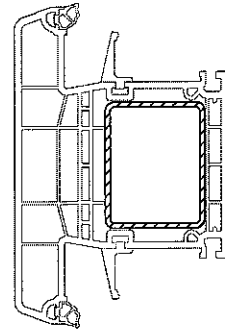
 12



40 x 50

	1251886	1241845@	1253157@
	2	3	4
lx	8,5	11,4	13,7
ly	12	16,1	19,5
	6	6	6

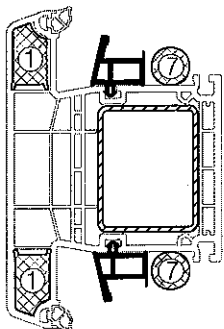

GENEO® PHZ		
	Passivhaus-Mittelsteg	1627079
①	Thermomodul Blr/Pf	1353337
⑦	Thermomodul Festverglasung	1353361

GENEO® PROFILDRUCK

Ausgleichsprofile

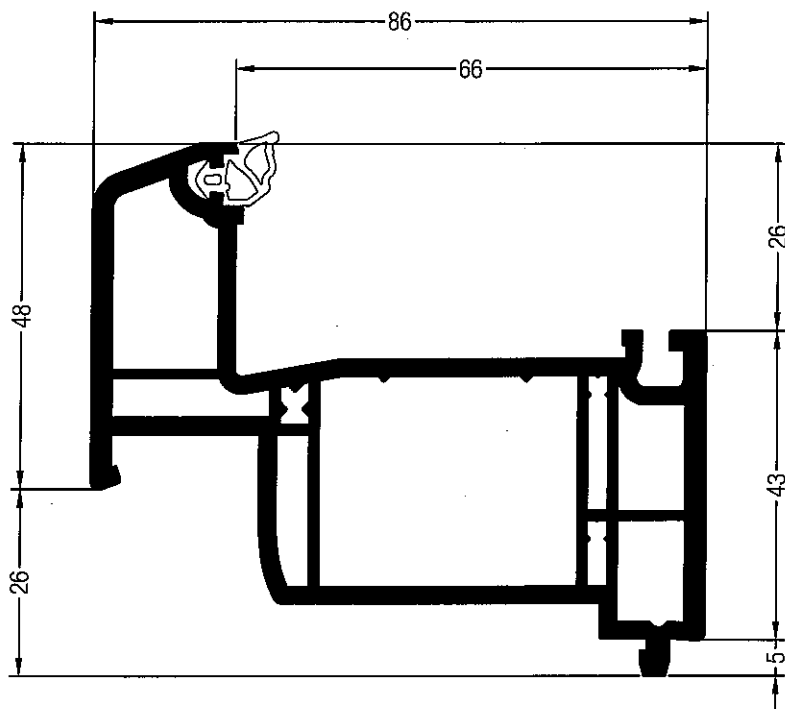

Ausgleichsprofil 48 GENE0®
(in Verbindung mit Flügel Z 57 GENE0®)

- 1532265
 1562265
 24

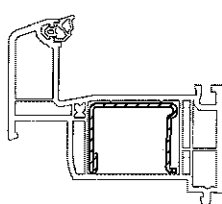

35 x 28

	1244516	1244526
	1,5	2
I_x	2,7	3,5
I_y	1,3	1,7
	6	6

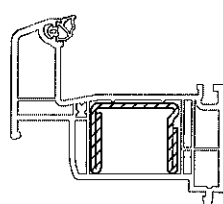

35 x 28

	1244536
	2
I_x	5
I_y	2
	6

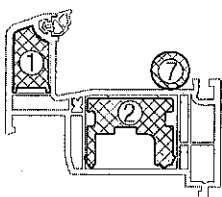

GENEO® PHZ		
①	Thermomodul Bir/Pf	1353337
②	Thermomodul 35 x 28	1260013
⑦	Thermomodul Festverglasung	1353361

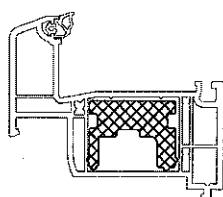

Thermomodul
35 x 28

- 1260013
 50

GENEO® PROFILDRUCK

Ausgleichsprofile

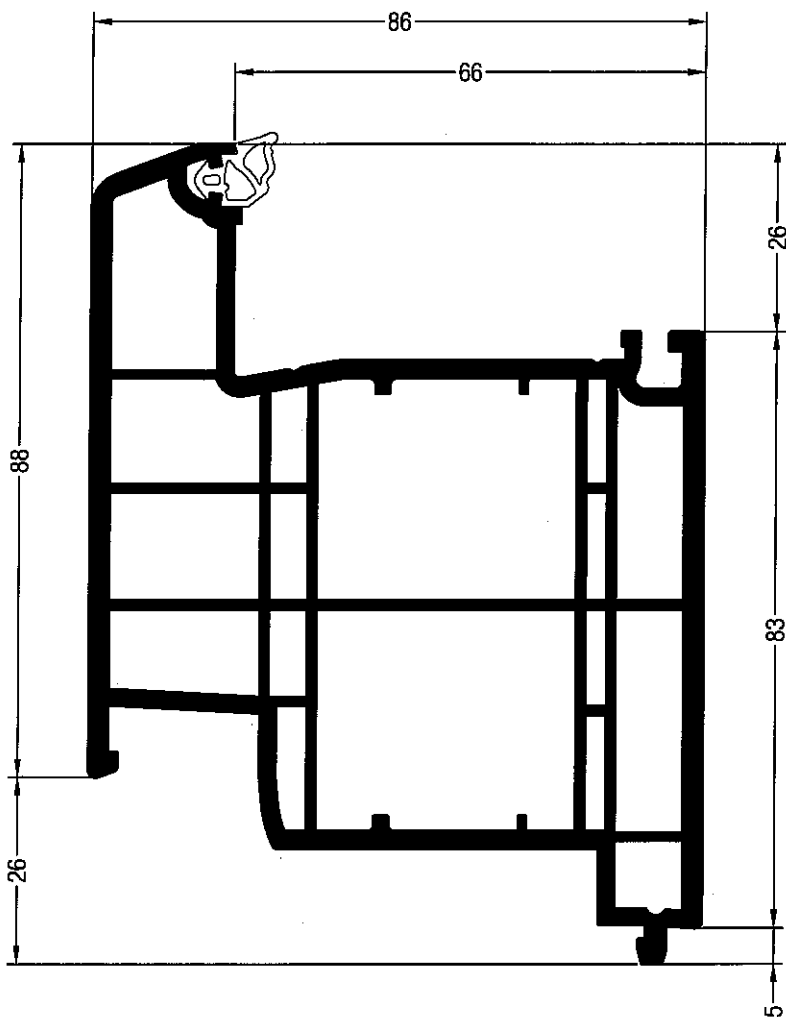

Ausgleichsprofil 88 GENEО®
(in Verbindung mit Haustürflügel GENEО® oben)

- 1532395
 @
 1562395 @
 12

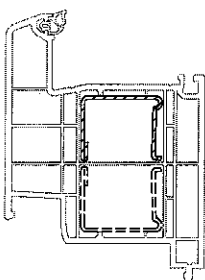

35 x 28

	1244516	1244526
	1,5	2
lx	2,7	3,5
ly	1,3	1,7
	6	6

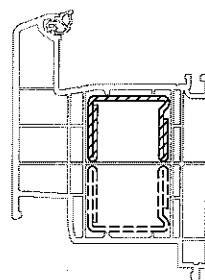

35 x 28

	1244536
	2
lx	5
ly	2
	6

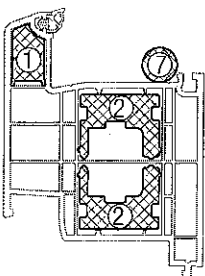

GENEO® PHZ		
①	Thermomodul Blr/Pf	1353337
②	Thermomodul 35 x 28	1260013
⑦	Thermomodul Festverglasung	1353361

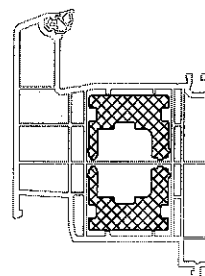

Thermomodul
35 x 28
1260013
 50

GENEO® PROFILDRUCK

Flügel

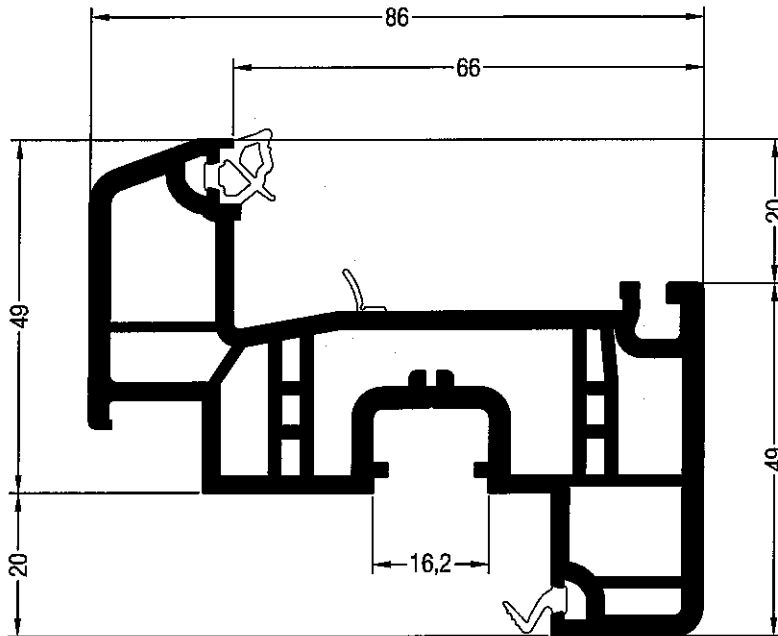

Flügel Z 49 GENEО®

RAU-FIPRO®

1532116

1562116

24

lx	1,8
ly	0,5

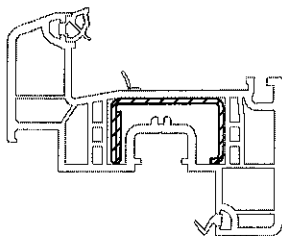

35 x 20

	1261831
	1,5
lx	2,5
ly	0,56
	6

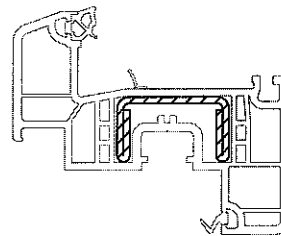

35 x 20

	1351893
	2
lx	3,8
ly	0,77
	6

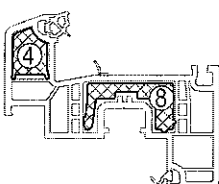

GENEO® PHZ		
	Thermomodul 35 x 20	1260033
	Thermomodul Flügel	1353336

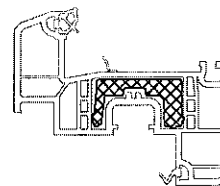

Thermomodul

35 x 20

1260033

50

GENEO® PROFILDRUCK

Flügel

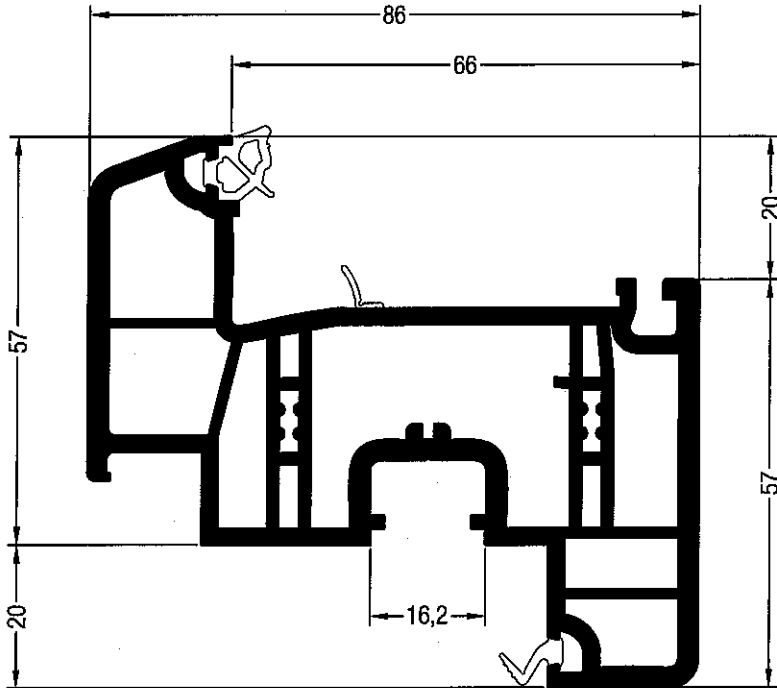

Flügel Z 57 GENEÓ®

RAU-FIPRO®

- 1532036
- 1562036
- 24

lx	2
ly	0,8

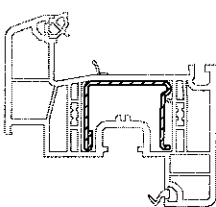

35 x 28

	1244516	1244526
	1,5	2
lx	2,7	3,5
ly	1,3	1,7
	6	6

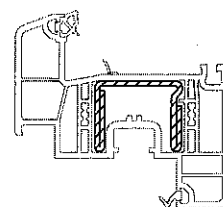

35 x 28

	1244536
	2
lx	5
ly	2
	6

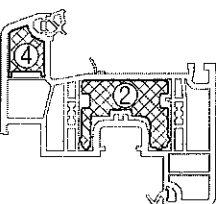

v		
②	Thermomodul 35 x 28	1260013
④	Thermomodul Flügel	1353336

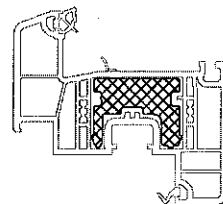

Thermomodul

35 x 28

1260013

50





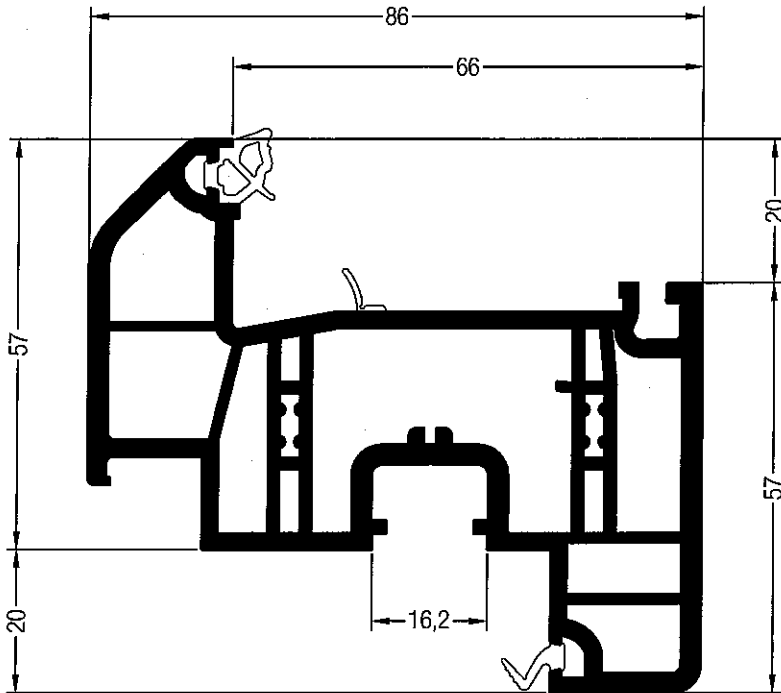



GENEO® PROFILDRUCK

Flügel



Flügel A 57 GENEО®

RAU-FIPRO®



- 1532226  
-   @
-   @
- 1562226   @
-  24

lx	2
ly	0,8

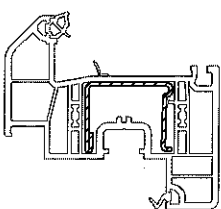
 Flügel A 57 ist nicht in Verbindung mit gasteilender Sprosse einsetzbar.



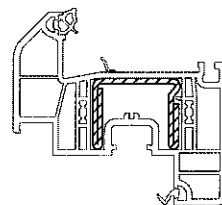

35 x 28

	1244516	1244526
	1,5	2
lx	2,7	3,5
ly	1,3	1,7
	6	6



35 x 28

v	1244536
	2
lx	5
ly	2
	6

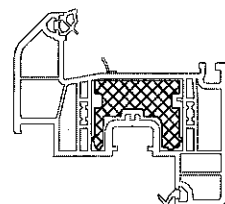

Thermomodul

35 x 28

1260013 

 50

GENEO® PROFILDRUCK

Flügel

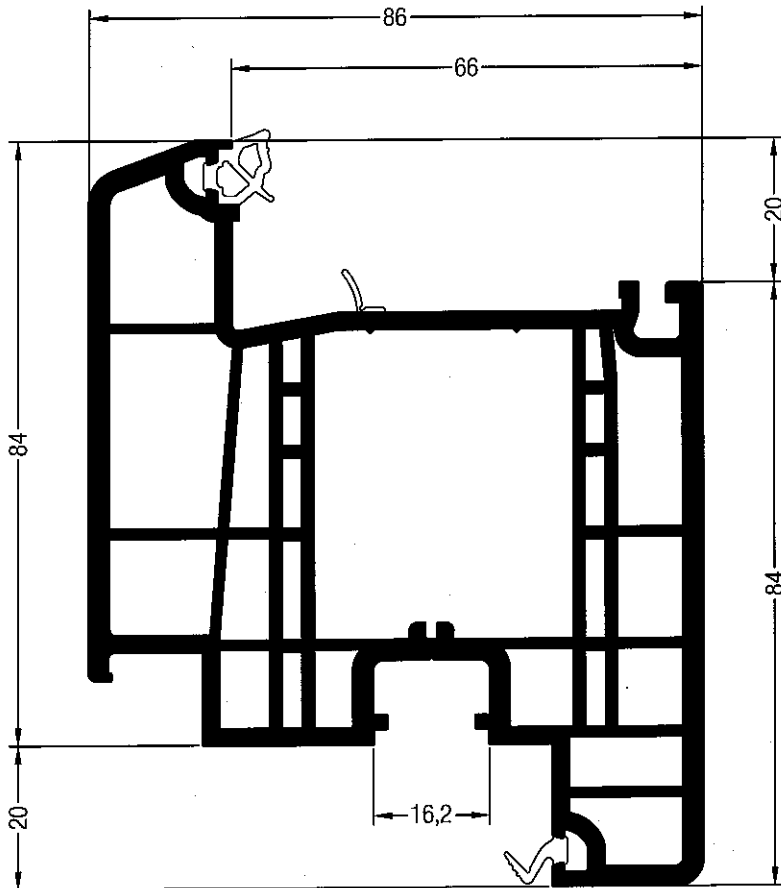

Flügel Z 84 GENEО®

RAU-FIPRO®

- 1532136
- 1562136
- 12

lx	2,9
ly	2,3

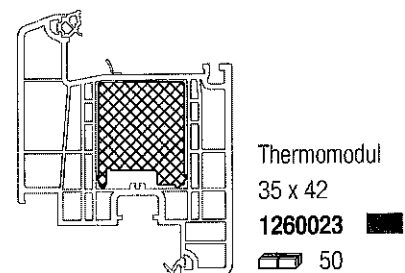
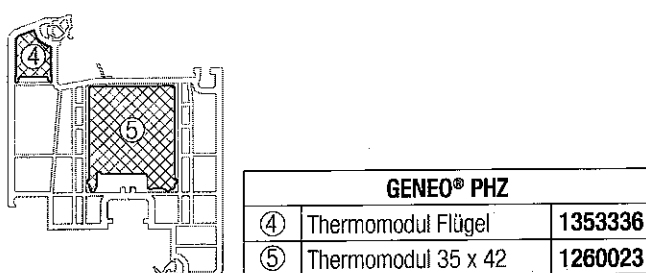
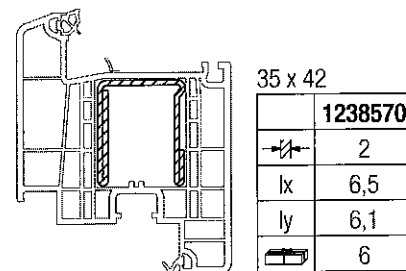
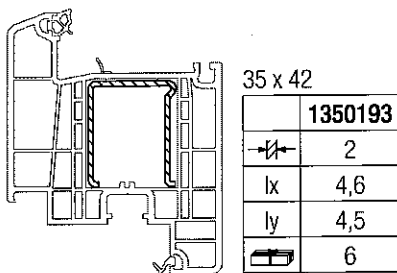

GENEO® PROFILDRUCK

Flügel

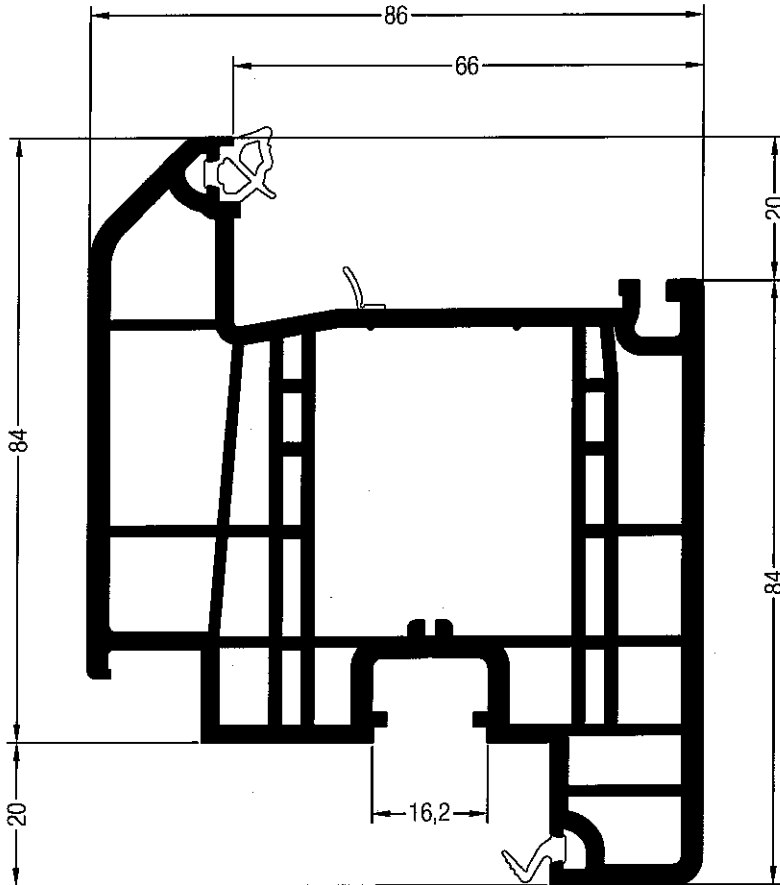

Flügel A 84 GENEÓ®

RAU-FIPRO®

- 1532236
- 1562236
- 12

lx	2,9
ly	2,3

Flügel A 84 ist nicht in Verbindung mit gasteilender Sprosse einsetzbar.

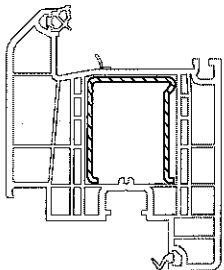

35 x 42

	1350193
	2
lx	4,6
ly	4,5
	6

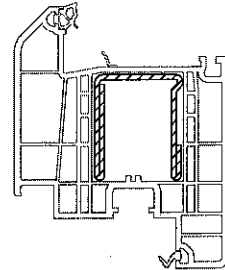

35 x 42

	1238570
	2
lx	6,5
ly	6,1
	6

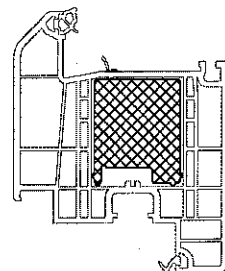

Thermomodul
35 x 42

	1260023
	50

GENEO® PROFILDRUCK

Flügel

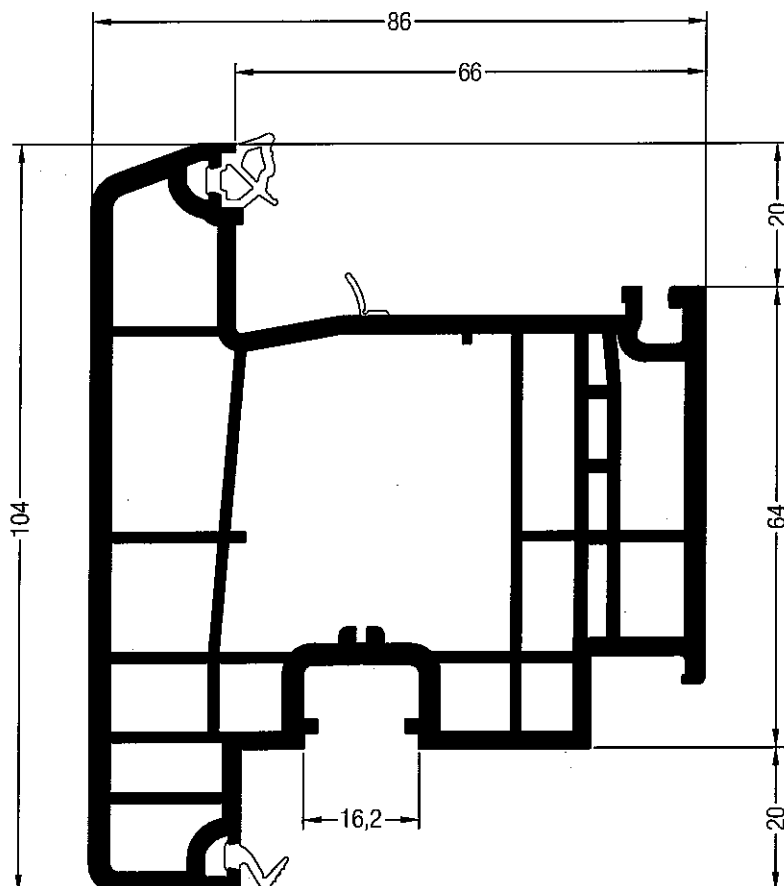

Flügel T 104 GENEÓ®

RAU-FIPRO®

1532146



1562146



12

lx	2,8
ly	2,3

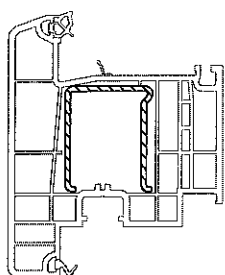

35 x 42

	1350193
	2
lx	4,6
ly	4,5
	6

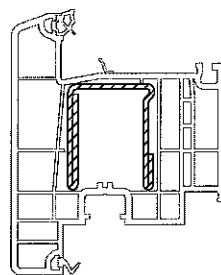

35 x 42

	1238570
	2
lx	6,5
ly	6,1
	6

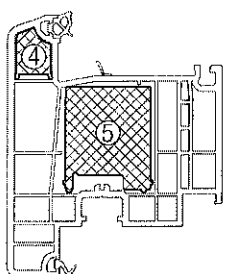

GENEO® PHZ		
④	Thermomodul Flügel	1353336
⑤	Thermomodul 35 x 42	1260023

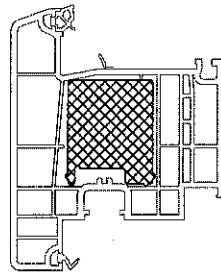

Thermomodul

35 x 42

1260023

50

GENEO® PROFILDRUCK

Flügel

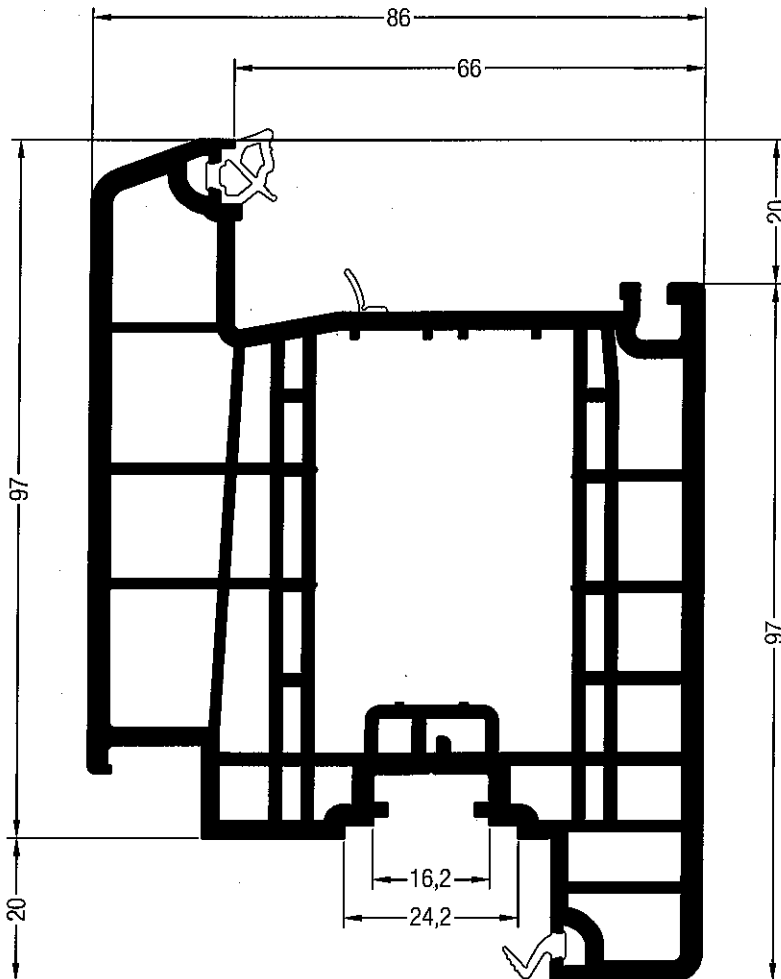

Haustürflügel Z GENEO®
RAU-FIPRO®

- 1532166
 @
 @
 1562166
 13

lx	3,5
ly	3,6

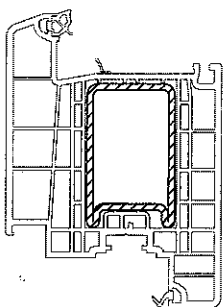

35 x 57

	1353385
	2,5
lx	8,9
ly	17,3
	6

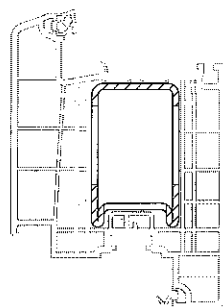

35 x 57

v	1353386
	2,5
konfektioniert für Schlossseite	
	2,4

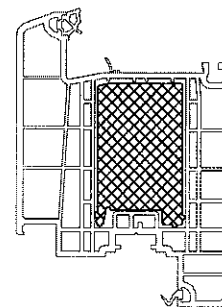

Thermomodul
35 x 57

1260043	
	50

GENEO® PROFILDRUCK

Flügel

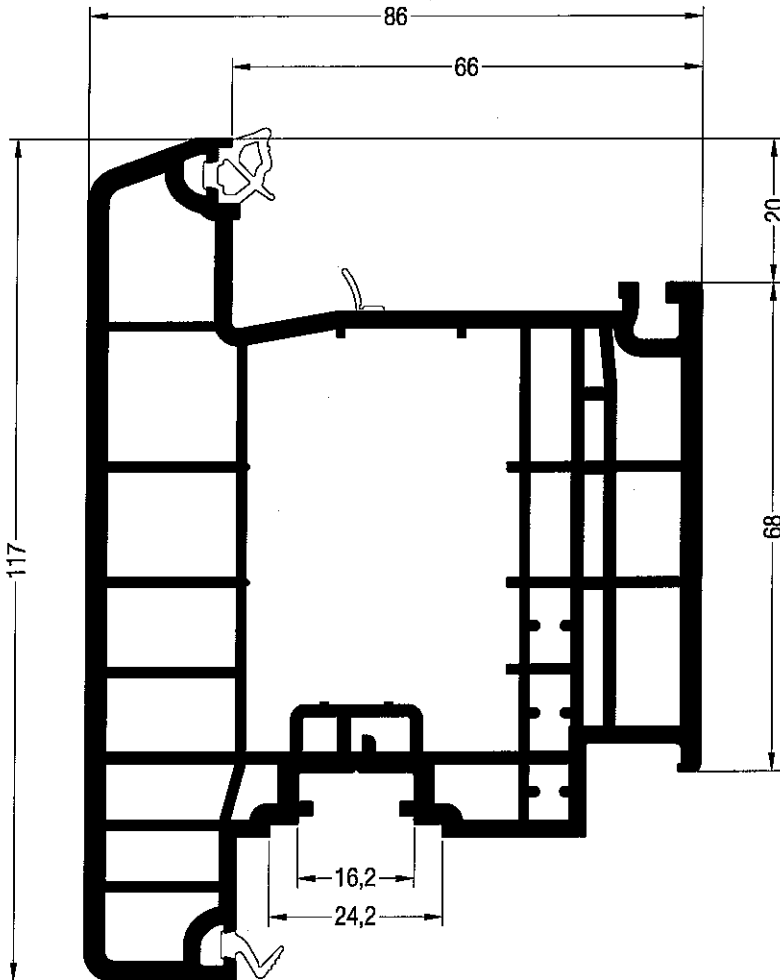

Haustürflügel T GENEO®

RAU-FIPRO®

- 1532176
- 1562176
- 13

lx	3,5
ly	3,6

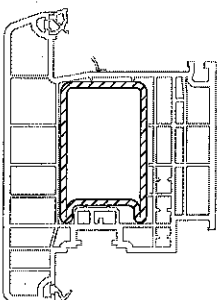

35 x 57

	1353385
	2,5
lx	8,9
ly	17,3
	6

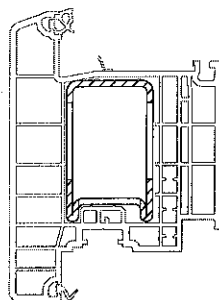

35 x 57

	1353386
	2,5
konfektioniert für Schlosseite	
	2,4

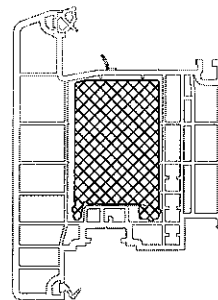

Thermomodul
35 x 57
1260043

50

GENEO® PROFILDRUCK

Flügelprossen

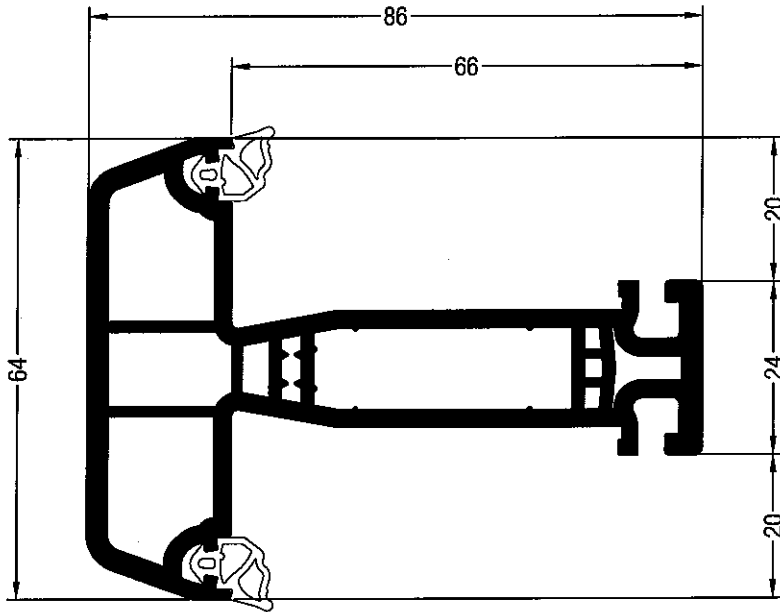

Sprasse 64/86

- 1532295
- 1562295
- 36

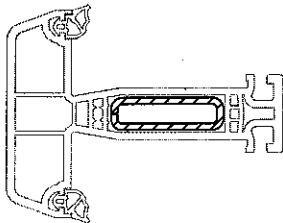

35 x 10

	1261801
	2
lx	1,8
ly	0,22
	6

GENEO® PROFILDRUCK

Profile für mehrflügelige Fenster ohne festen Pfosten

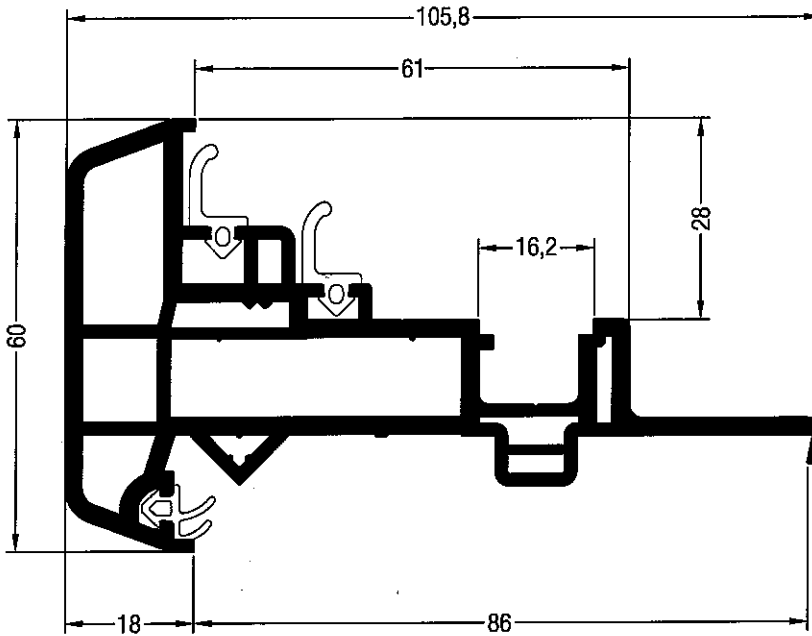

Stulpprofil GENEО®

- 1532075
- @
- 1562075
- 24

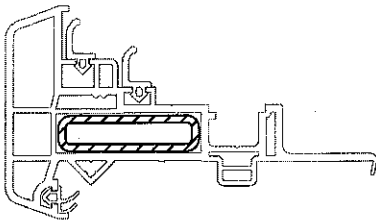

40 x 10

	1247898
	2
l_x	2,7
l_y	0,25
	6

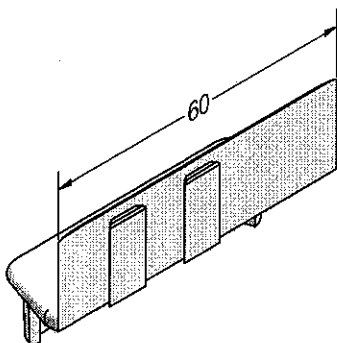

Endkappe Stulpprofil außen GENEО®

ASA

1350195

1350295

50

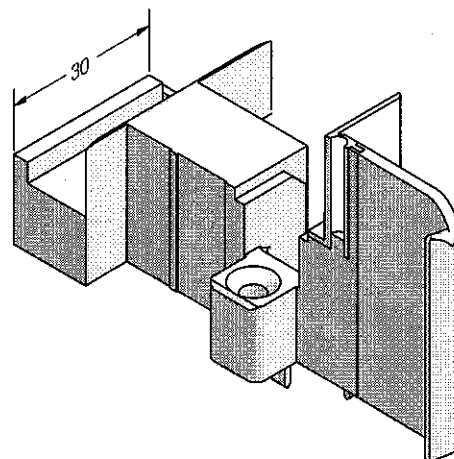

Endkappe Stulpprofil innen GENEО®

ASA

1355265

1355275

50

Profile für mehrflügelige Fenster ohne festen Pfosten

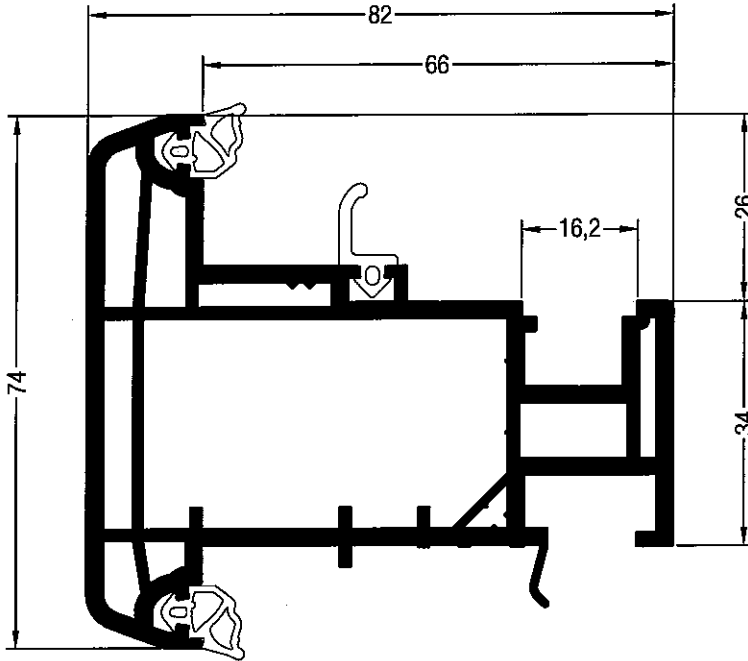

Blindpfosten Bautiefe 86

- 1532085
- 1562085
- 24

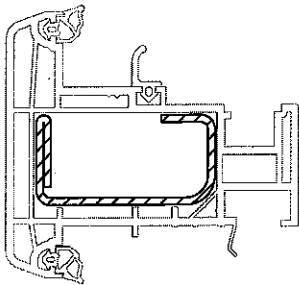

50 x 25

1351658	
	2
lx	9,1
ly	1,9
	6

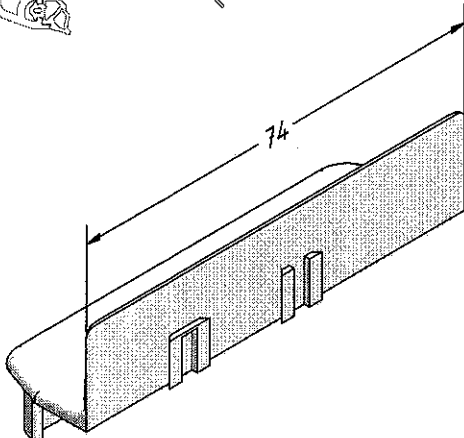

Endkappe Blindpfosten außen Bautiefe 86

ASA

- 1350595
- 1350695
- 50

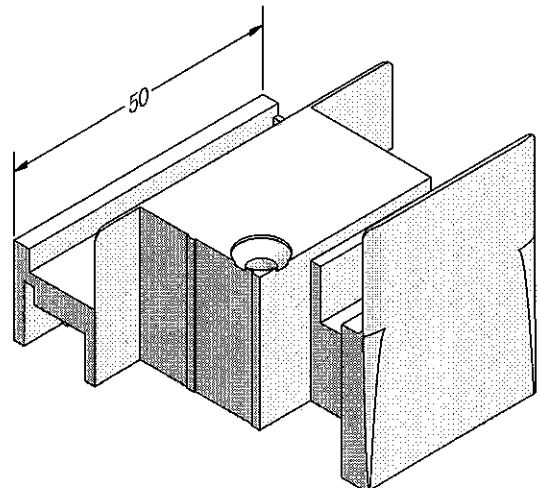

Endkappe Blindpfosten innen GENEО®

ASA

- 1355285
- 1355295
- 50

GENEO® PROFILDRUCK

Profile für mehrflügelige Fenster ohne festen Pfosten

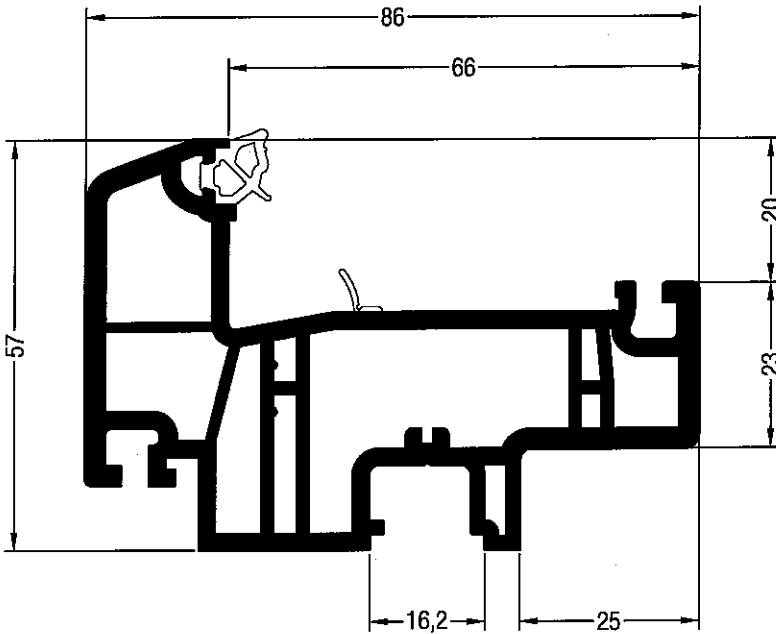

Stulpflügel Z 57 GENEО®

RAU-FIPRO®

1532446

24

ix	1,5
ly	0,4

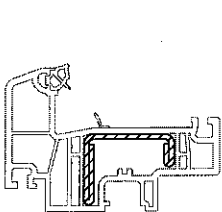

35 x 28

	1356120
	2
ix	3,7
ly	1,4
	6

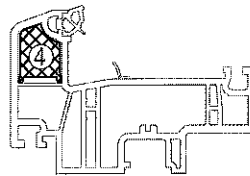

GENEO® PHZ		
④	Thermomodul Flügel	1353336

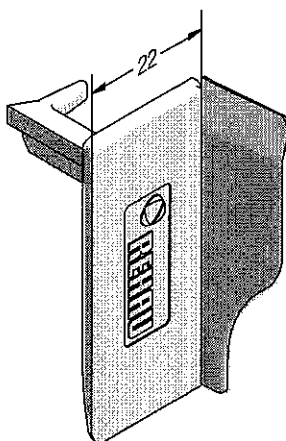

Endkappe Stulpflügel GENEО®

TPE

1351985

1351995

50

GENEO® PROFILDRUCK

Profile für mehrflügelige Fenster ohne festen Pfosten

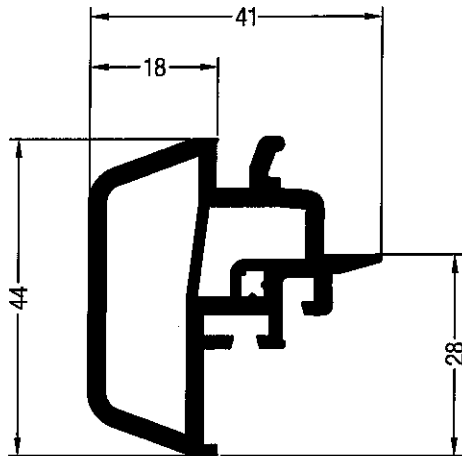

Stulpleiste GENEО®

- 1532370
- 1562370
- 36

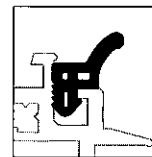

	1212353
	1212363

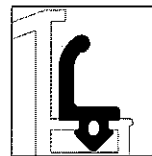

	1211013
	1211023

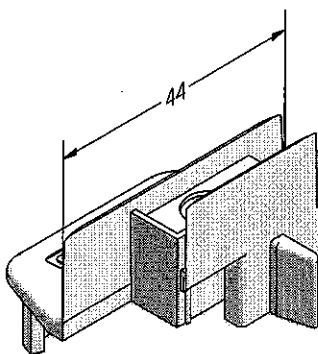

Endkappe Stulpleiste GENEО®

ASA

- 1352075
- 1352085
- 50

GENEO® PROFILDRUCK

Bodenschwelle und Zubehör

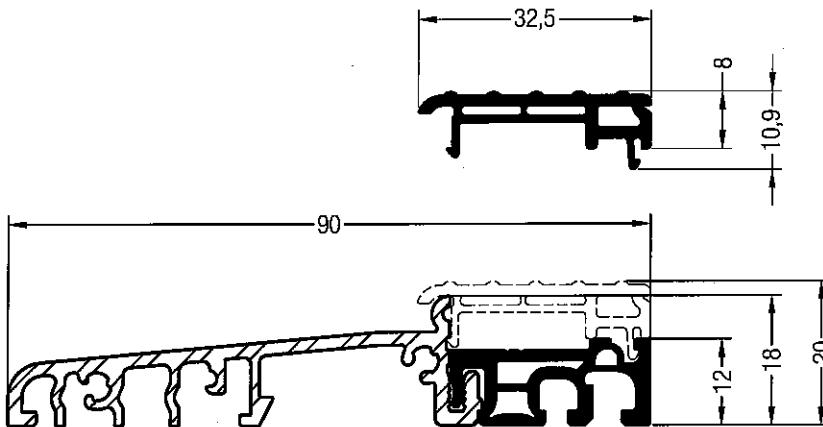

Set Bodenschwelle Bautiefe 86

1350308 

 60

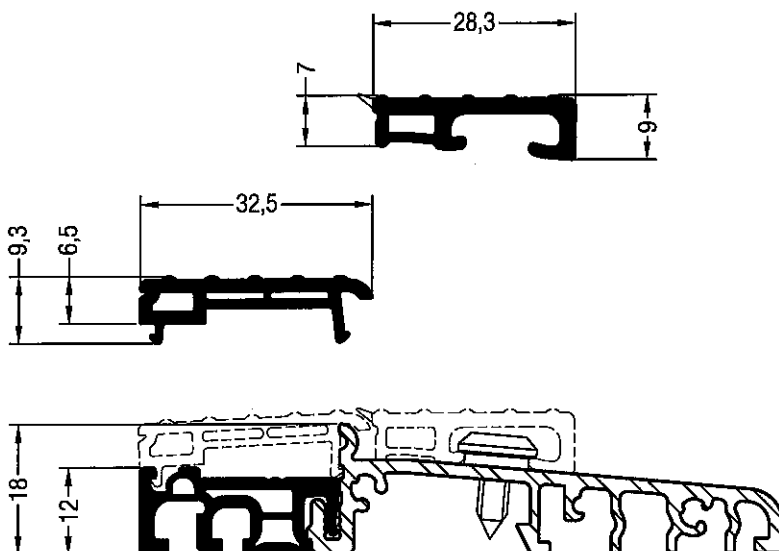

Set Bodenschwelle außenöffnend Bautiefe 86

1356030 



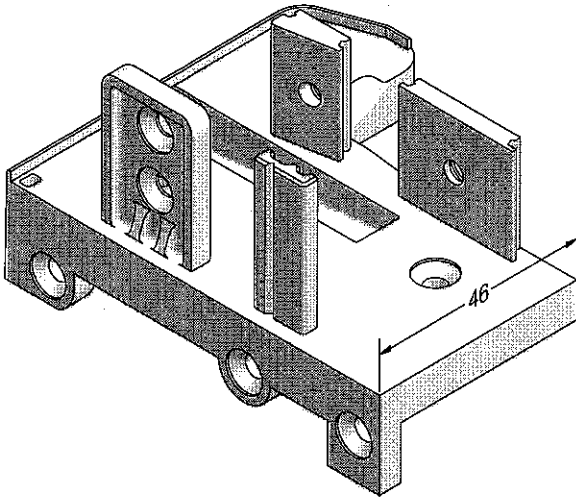

 30

Bodenschwelle und Zubehör



Schwellenhalter Blendrahmen 72 GENE0®

ASA

1350309     @

1350310     @

 50

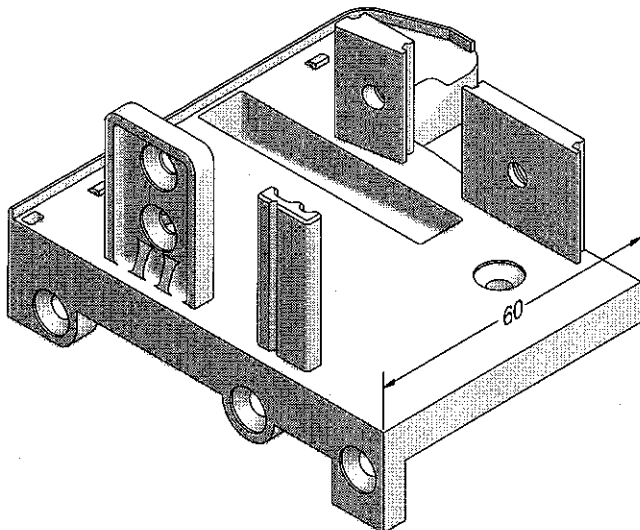

Schwellenhalter Blendrahmen 86 GENE0®

ASA

1350311     @

1350312     @

 50